



SINCE 1946

F1

BROOKLYN



100% MADE IN ITALY

ITALIANO



ENGLISH



F1

BROOKLYN



mod. 101cm





mod. 131cm



mod. 151cm

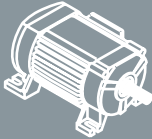
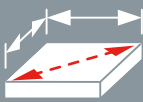

mod. 181cm

| Art. Item |  |  |  |  |
|--------------------|---|---|---|--|
| F1-101 | 230 V~ 2,2 kW (3 HP) 13,5 A 50 Hz 2.800 min ⁻¹ | 101 (71x71) cm 40 (28x28) inch | 0 ÷ 5 cm 0 ÷ 2 inch | 250/25,4 mm 10 / 1 inch |
| F1-131 | | 131 (92x92) cm 51,5 (36x36) inch | | |
| F1-151 | | 151 (106x106) cm 59,5 (41,5x41,5) inch | | |
| F1-181 | | 181 (128x128) cm 71,5 (50x50) inch | | |
| F1-101-115V | 115 V~ 1,5 kW (2 HP) 18 A 60 Hz 3.360 min ⁻¹ | 101 (71x71) cm 40 (28x28) inch | 0 ÷ 5 cm 0 ÷ 2 inch | 250/25,4 mm 10 / 1 inch |
| F1-131-115V | | 131 (92x92) cm 51,5 (36x36) inch | | |
| F1-151-115V | | 151 (106x106) cm 59,5 (41,5x41,5) inch | | |
| F1-181-115V | | 181 (128x128) cm 71,5 (50x50) inch | | |

ISTRUZIONI D'USO



Obbligo



Divieto



Pericolo



Leggere e conservare accuratamente.

1 TAGLIERINA ELETTRICA AD ACQUA

- **ESCLUSIVAMENTE** per il taglio e lo smusso (Jolly) di piastrelle in gres, gres porcellanato, klinker, cotto, monocottura, ceramica, cemento e materiali lapidei.
- Solo per uso professionale.



2

- Prima di lasciare l'Officina di produzione, la Vostra macchina è stata sottoposta a seri collaudi a garanzia della qualità, della sicurezza e dell'efficienza del prodotto. Seguendo attentamente le istruzioni contenute nel presente manuale, assicurerete alla Vostra macchina, in condizioni d'uso normali, una lunga durata.
- Prima di usare la macchina leggere attentamente questo manuale di istruzioni, al fine di evitare incidenti o malfunzionamenti.
- Non manomettere in alcun modo le protezioni e i ripari previsti dal costruttore.
- Non modificare in alcun modo nessuna parte della macchina.
- Eventuali modifiche possono essere apportate solo dal costruttore.
- Usare solo ricambi originali.
- La Brevetti MONTOLIT declina ogni responsabilità in caso di inosservanza.

3 SEGUIRE SCRUPolosAMENTE LE NORME VIGENTI IN MATERIA D'IGIENE E DI SICUREZZA SUL LAVORO

- In riferimento alla direttiva 2003/10/CE è obbligatorio l'uso dei dispositivi individuali di protezione dell'udito.
- Le vibrazioni trasmesse dalla macchina e valutate secondo la normativa UNI-EN-ISO 5349-1-2004 sono da considerarsi irrilevanti.



4 TARGHETTA IDENTIFICATIVA

The identification plate is a blue rectangular label with the following fields and icons:

- Divieti:** A row of four icons: a blue circle with a white exclamation mark, a red circle with a white slash over a gear, a red circle with a white slash over a hand, and a red circle with a white slash over a foot.
- Disposizioni RAEE:** A row of two icons: a blue circle with a white exclamation mark and a blue circle with a white exclamation mark.
- Modello:** A row of two icons: a blue circle with a white exclamation mark and a blue circle with a white exclamation mark.
- Art.:** A field for the article number, with a CE mark to its right.
- Ø max.:** A field for the maximum diameter, followed by a slash and a field for units.
- Rpm max.:** A field for the maximum RPM, followed by a slash and a field for units (kg).
- Mat.:** A field for the material.
- Nome del costruttore:** The MONTOLIT logo and name, with the address "Via Turconi, 25 • Cantello (VA) ITALIA • www.montolit.com" below it.
- Dispositivi di protezione individuale:** A row of four icons: a blue circle with a white exclamation mark, a blue circle with a white exclamation mark, a blue circle with a white exclamation mark, and a blue circle with a white exclamation mark.
- Diametro e foro del disco diamantato:** A field for the diameter and hole of the diamond disc.
- Certificazione Europea di Sicurezza:** The CE mark.
- Peso:** A field for the weight.
- Anno di produzione:** A field for the production year.
- Numero di matricola:** A field for the serial number.
- Max numero di giri:** A field for the maximum number of revolutions.

5 | MONTAGGIO E PREPARAZIONE



| | Peso (kg) | Capacità (lt) |
|------------|-----------|---------------|
| mod. 101cm | 75 | 25 |
| mod. 131cm | 85 | 25 |
| mod. 151cm | 100 | 25 |
| mod. 181cm | 112 | 25 |

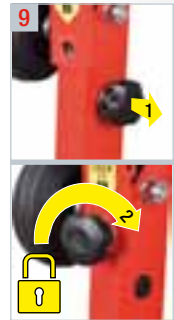
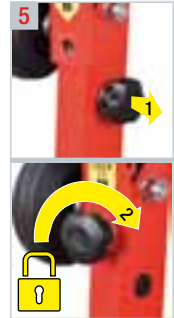

10 • PATENTED ADJUSTABLE LEGS SYSTEM • x mod. 151/181cm

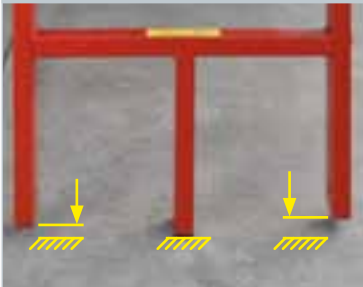

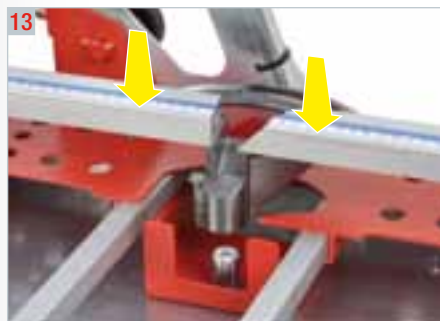

6 ALIMENTAZIONE ELETTRICA



ATTENZIONE!

- Verificare l'integrità del cavo e dell'interruttore.
- Rispettare la tensione (V) e la frequenza (Hz) indicate sulla macchina.
- Effettuare l'allacciamento elettrico con messa a terra (giallo-verde) ad una presa IP67 (2P+T) protetta da differenziale magnetotermico IΔN 0,01A.
- Verificare periodicamente il funzionamento dell'interruttore differenziale.
- Per l'utilizzo di una prolunga, usare esclusivamente spina e presa IP67 (2P+T) e cavo 3 x 2,5mm² del tipo H07RN-F (lunghezza max 5m).
- Verificare la disposizione del cavo di alimentazione: non deve intralciare le manovre, non deve essere soggetto ad urti o danneggiamenti.
- Togliere l'allacciamento elettrico in ogni caso di manutenzione ordinaria o straordinaria, per il caricamento del liquido refrigerante (acqua), o per la sostituzione del disco diamantato.
- Modelli provvisti di interruttore con protezione termica e bobina di minima tensione.
- Evitare di forzare il motore durante la lavorazione. La macchina possiede un sistema di sicurezza che la protegge dal surriscaldamento del motore, di conseguenza, se si arresta senza motivo apparente, bisogna attendere alcuni minuti in modo che si disattivi il circuito di sicurezza (quasi sicuramente avremo sottoposto la macchina a uno sforzo eccessivo, dovremo quindi moderare la velocità di avanzamento del taglio).
- Motore monofase IP55 con emissioni elettromagnetiche inferiori ai limiti previsti.
- In ogni caso di disfunzioni riguardo: interruttore, cavo, motore, pompa, consultare un esperto o il nostro Ufficio Tecnico.

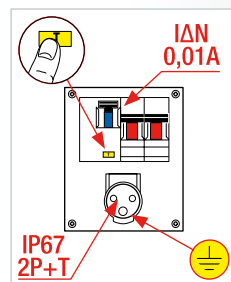

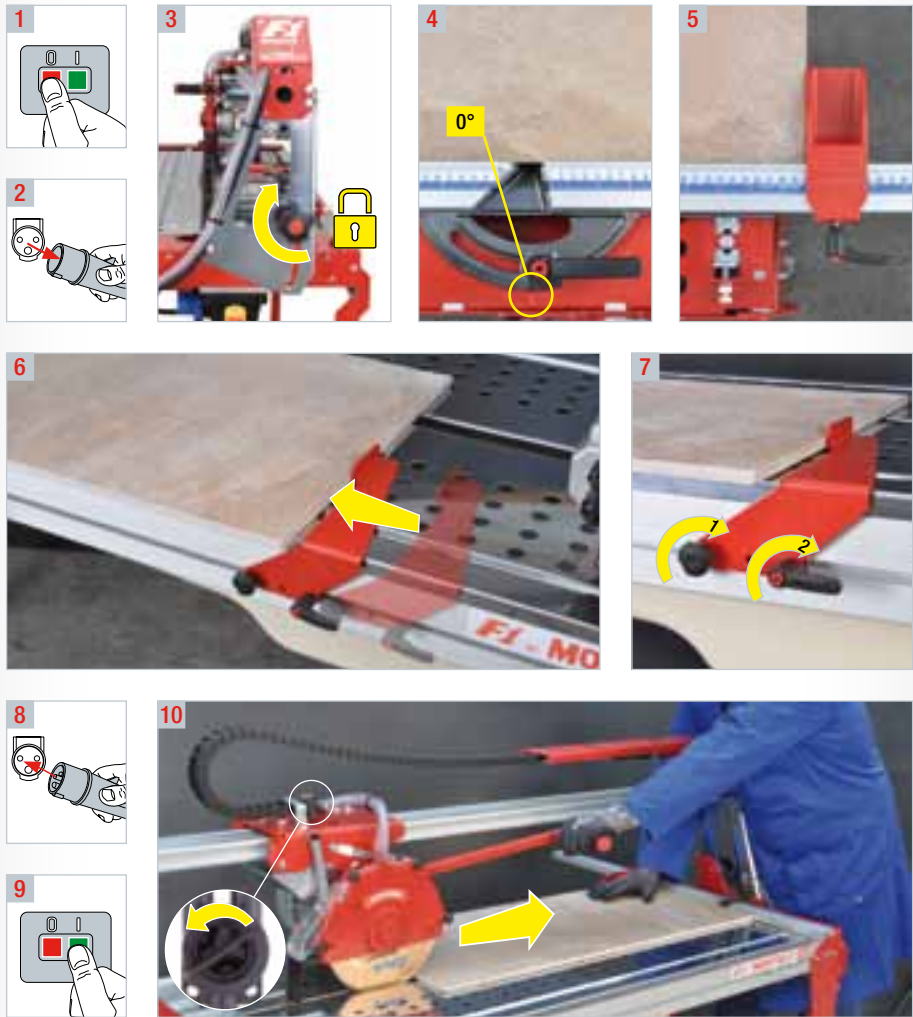

- Posizionare la piastrina in appoggio alla squadra. Bloccarla con Squeeze System (fig. 6/7).
- Premere verso il basso fino a fine corsa la maniglia di azionamento e bloccarla.
- La posizione corretta delle mani è indicata in figura 10.
- Procedere al taglio accostando lentamente il disco diamantato al materiale da tagliare avanzando con velocità proporzionata allo spessore ed alla durezza del materiale.
- Rallentare la velocità di avanzamento in prossimità di fine taglio.
- Dopo avere eseguito il taglio, tramite l'interruttore, spegnere il motore. Riportare il motore nella posizione iniziale.

8.1 CORRETTO UTILIZZO - FORI QUADRATI E RETTANGOLARI

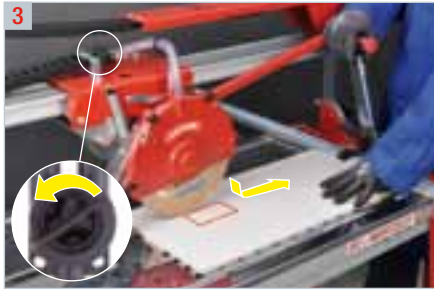
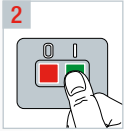
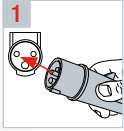

- Spessore massimo del materiale 3,5 cm.
- Premere verso il basso la maniglia di azionamento in modo che il disco entri nella piastrina fino alla sua fuoriuscita dal lato opposto.
- La posizione corretta delle mani è indicata in figura 3.

8.2 CORRETTO UTILIZZO - 45°

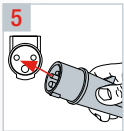
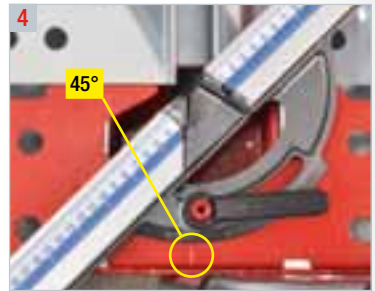
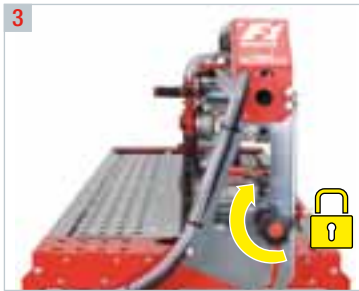
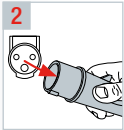

- Posizionare la piastrina in appoggio alla squadra.
- Premere verso il basso fino a fine corsa la maniglia di azionamento e bloccarla.
- La posizione corretta delle mani è indicata in figura 7.
- Procedere al taglio accostando lentamente il disco diamantato al materiale da tagliare avanzando con velocità proporzionata allo spessore ed alla durezza del materiale.
- Rallentare la velocità di avanzamento in prossimità di fine taglio.
- Dopo avere eseguito il taglio, tramite l'interruttore, spegnere il motore. Riportare il motore nella posizione iniziale.
- Qualora si verifichi la rottura della parte terminale della piastrina (ultimo centimetro) ravvivare il disco diamantato. Se il difetto permane si può ovviare nel modo seguente:
 - 1 - effettuare un taglio di circa 2 cm da un lato della piastrina.
 - 2 - girarla ed eseguire il taglio fino al ricongiungimento con il taglio di 2 cm precedentemente eseguito.

8.3 CORRETTO UTILIZZO - JOLLY

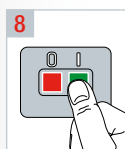
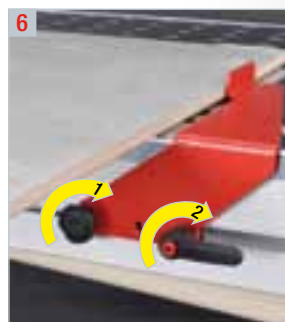
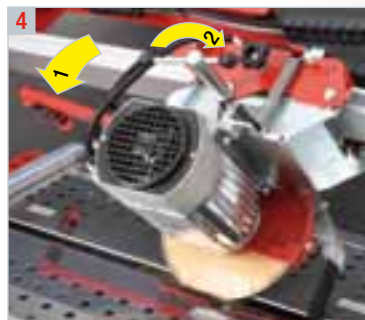
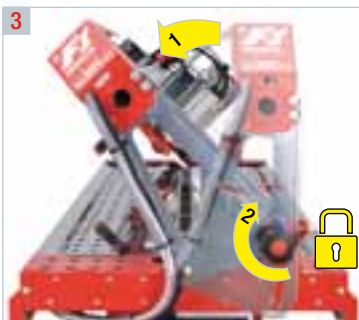
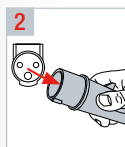

- Posizionare la piastrella in appoggio alla squadra. Bloccarla con Squeeze System (fig. 5/6).
- Premere verso il basso fino a fine corsa la maniglia di azionamento e bloccarla.
- La posizione corretta delle mani è indicata in figura 9.
- Procedere al taglio accostando lentamente il disco diamantato al materiale da tagliare avanzando con velocità proporzionata allo spessore ed alla durezza del materiale.
- Rallentare la velocità di avanzamento in prossimità di fine taglio.
- Dopo avere eseguito il taglio, tramite l'interruttore, spegnere il motore. Riportare il motore nella posizione iniziale.

9 | ISTRUZIONI PER LA MOVIMENTAZIONE ED IL TRASPORTO

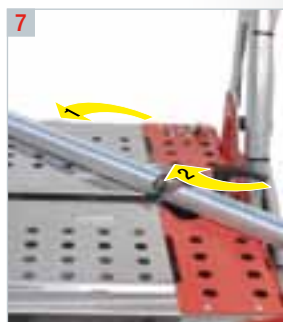
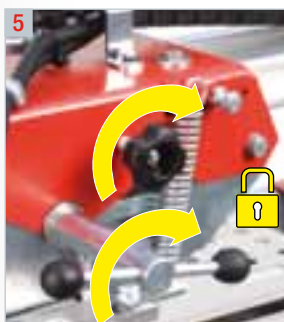
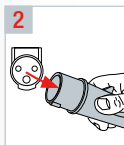



10 SOSTITUZIONE DEL DISCO DIAMANTATO

- Usare solo dischi diamantati del diametro e del tipo stabilito dalla Brevetti MONTOLIT.
- Per una maggiore precisione ed economia di taglio scegliere il disco diamantato MONTOLIT specifico all'uso consultando il catalogo MONTOLIT.



IMPORTANTE!

- L'utensile diamantato ed il relativo sistema di fissaggio devono sempre essere in condizioni perfette.
- È pericoloso l'utilizzo di utensili diamantati con eccessiva usura, eccentricità e/o microfessurazioni sulla corona diamantata.
- Nel caso in cui l'utensile non tagliasse occorrerà ravvivarlo utilizzando l'apposito stick ravvivatore MONTOLIT art. 395B.

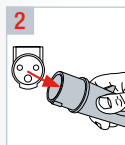
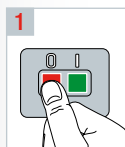

ATTENZIONE! Filetto sinistro: per svitare, girare in senso orario

11 | PULIZIA PERIODICA

- Prima di procedere alla pulizia, alla manutenzione o alla riparazione della macchina, così come prima di effettuare il trasporto, la macchina va spenta e bisogna staccare la spina.
- Pulizia della macchina:
 - non usare getti d'acqua ma una spugna umida,
 - mantenere pulita la barra di scorrimento (non ingrassare).
- Per la pulizia è sconsigliato l'uso di utensili che possano intaccare la vernice.
- Pulizia vasca:
 - estrarre la griglia e togliere il tappo, lasciare defluire l'acqua dalla vasca e procedere alla pulizia,
 - estrarre la vasca e pulirla dai detriti e dai residui di taglio.

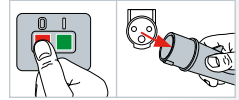
**12 | MANUTENZIONE ORDINARIA**

- Esaminare periodicamente i cavi della macchina e, nel caso in cui siano danneggiati, farli riparare dal servizio tecnico autorizzato.
- Mantenere le impugnature asciutte, pulite e senza olio o grasso.

**ATTENZIONE!**

Una protezione o un'altra parte danneggiata, va riparata correttamente o fatta sostituire dal servizio tecnico autorizzato, salvo che sia indicato diversamente in questo manuale d'istruzioni.

13 | MESSA FUORI SERVIZIO

- Effettuare la pulizia periodica, la manutenzione ordinaria.
- Immagazzinare il tutto in un luogo asciutto, sicuro e lontano dalla portata dei bambini.

14 | SMANTELLAMENTO DELLA MACCHINA

- Attenersi alle disposizioni locali per lo smaltimento di prodotti elettrici.
- Attraverso una rottamazione ecologica è possibile recuperare materiali pregiati.
- I componenti elettrici utilizzati per la costruzione sono in accordo alla normativa RoHS 2002/95/EC.
- Per ulteriori informazioni contattare il nostro Ufficio Tecnico.

**15 | ACCESSORI**

- La macchina viene fornita corredata di una chiave a forchetta semplice ed una chiave esagonale da utilizzarsi per il montaggio/smontaggio del disco e dal presente manuale d'uso e manutenzione.

16 LOCALIZZAZIONE GUASTI

| PROBLEMA | CAUSA | RIMEDIO |
|---|---|---|
| La macchina non funziona. | <ul style="list-style-type: none"> • La spina è mal inserita nella presa di alimentazione. • Il cavo di alimentazione è interrotto. • Non c'è tensione alla presa di corrente. • L'interruttore è danneggiato. • Motore non collegato. | <ul style="list-style-type: none"> • Spingere a fondo la spina nella presa. • Rivolgersi al centro assistenza autorizzato o al rivenditore di fiducia. |
| Il motore parte con difficoltà. | <ul style="list-style-type: none"> • Il condensatore è guasto. • Al motore non arriva la tensione indicata sull'etichetta dati tecnici. | <ul style="list-style-type: none"> • Rivolgersi al centro assistenza autorizzato o al rivenditore di fiducia. |
| La macchina si spegne durante il lavoro. | <ul style="list-style-type: none"> • Eccessiva temperatura del motore. | <ul style="list-style-type: none"> • Attendere che il motore si raffreddi. |
| Non arriva acqua al disco diamantato. | <ul style="list-style-type: none"> • La pompa non funziona. • Il livello dell'acqua nella vasca è troppo basso. • Il rubinetto è otturato. • Il tubo di ricircolo dell'acqua è piegato od otturato. • Fori otturati nel filtro o nel coprigirante della pompa. | <ul style="list-style-type: none"> • Verificare che la pompa sia libera da residui di taglio. Se è necessaria la sostituzione della pompa rivolgersi al centro assistenza autorizzato o al rivenditore di fiducia. • Aggiungere acqua nella vasca. • Pulire o sostituire il rubinetto. • Staccare dalla pompa il tubo di mandata acqua e soffiare. Pulirlo o sostituirlo a seconda dello stato di usura. • Liberare tutti i fori presenti nel filtro e nel coprigirante della pompa. |
| Il dispositivo di scorrimento ha eccessivo gioco. | <ul style="list-style-type: none"> • Eccessiva usura. | <ul style="list-style-type: none"> • Rivolgersi al centro assistenza autorizzato o al rivenditore di fiducia. |

17 GARANZIA

Validità 2 (due) anni a partire dalla data di vendita (fattura o bolla di consegna o scontrino fiscale). Guasti derivanti da un uso non conforme o da normale usura sono esclusi dalla presente garanzia.

Da sempre, la Brevetti MONTOLIT impiega e fornisce materiali di prima scelta. Si tratta di un impegno di serietà e moralità commerciale che eleva la Nostra Azienda al di sopra dello standard. Sicurezza e garanzia del prodotto costituiscono per noi motivo di vanto. Una realtà operativa che non è fatta solo di parole, ma anche di vere e proprie garanzie scritte. Infatti assicuriamo tutti i nostri prodotti contro i danni involontariamente cagionati in conseguenza di un fatto accidentale verificatosi per difetto di costruzione e fabbricazione del prodotto anche dopo la sua consegna e commercializzazione.



Descrizioni ed illustrazioni s'intendono fornite a semplice titolo indicativo. La Casa si riserva il diritto, ferme restando le caratteristiche essenziali dei modelli qui descritti ed illustrati, di apportare ai propri prodotti, in qualunque momento e senza preavviso, le eventuali modifiche da essa ritenute necessarie a scopo di miglioramento o per qualsiasi esigenza di carattere costruttivo o commerciale.

Si vieta ogni riproduzione totale o parziale dell'opera in qualsiasi formato e con qualsiasi mezzo o procedimento, sia meccanico, fotografico o elettronico, senza previa autorizzazione di Brevetti MONTOLIT S.p.A. Ciascuna delle succitate attività potrebbe condurre a conseguenti procedimenti penali.

USAGE INSTRUCTIONS



Necessity



Prohibited



Danger



Carefully read and maintain.

1 | ELECTRIC WATER CUTTER

- **EXCLUSIVELY** for the cutting and beveling (Jolly) of porcelain tile, klinker, terracotta, single-fired, ceramics, concrete and stone materials.
- For professional use only.



2 |

- Before leaving the production workshop, your machine has been subjected to serious testing to ensure its quality, safety and efficiency. By carefully following the instructions contained in this manual, you ensure a long life for your machine under normal usage conditions.
- Before using the machine, carefully read this instruction manual in order to avoid accidents or malfunctions.
- Do not tamper with the protections and guards provided by the manufacturer in any way.
- Do not modify any part of the machine in any way.
- All modifications must be made by the manufacturer only.
- Only use original spare parts.
- Brevetti MONTOLIT disclaims any liability in the event of non-compliance.

3 | CAREFULLY FOLLOW THE REGULATIONS IN PLACE REGARDING HEALTH AND SAFETY IN THE WORKPLACE

- The use of individual hearing protectors is mandatory as per Directive 2003/10/CE.
- The vibrations produced by the machine and evaluated according to regulation UNI-EN-ISO 5349-1-2004 are considered to be irrelevant.



4 | IDENTIFICATION PLATE

The identification plate is a blue rectangular label with the following fields and icons:

- Prohibitions:** A row of four red circles with white diagonal lines over black icons representing safety restrictions.
- RAEE provisions:** A row of four blue circles with white icons representing environmental regulations.
- Model:** A field for the machine model number.
- Art.:** A field for the article number, with a CE mark to its right.
- Ø max.:** A field for the maximum diameter, followed by a slash and a field for units.
- Rpm max.:** A field for the maximum RPM, followed by a field for units (kg).
- Mat.:** A field for the material type.
- Manufacturer name:** The text "BREVETTI MONTOLIT S.p.A." and "Via Turcori, 25+Castello (VA) ITALIA + www.montolit.com".
- Year of production:** A field for the production year.
- Registration number:** A field for the registration number.
- Max RPM:** A field for the maximum RPM.
- Weight:** A field for the weight.
- Personal protective equipment:** A field with icons for hearing, hand, foot, and eye protection.
- Diameter and bore of diamond disk:** A field for the diamond disk specifications.
- European Safety Certification:** The CE mark.

5 ASSEMBLY AND PREPARATION



| | Weight (kg) | Capacity (lt) |
|------------|-------------|---------------|
| mod. 101cm | 75 | 25 |
| mod. 131cm | 85 | 25 |
| mod. 151cm | 100 | 25 |
| mod. 181cm | 112 | 25 |

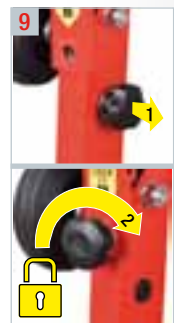
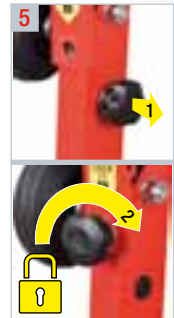

10 • PATENTED ADJUSTABLE LEGS SYSTEM • x mod. 151/181cm

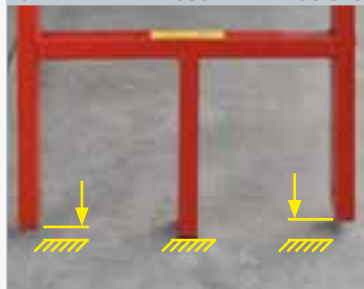

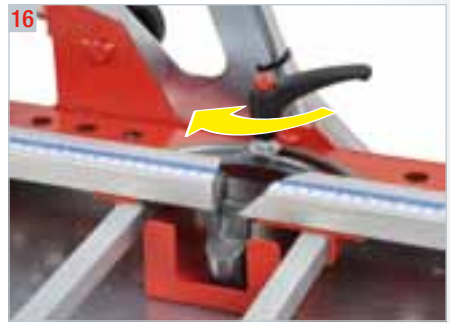
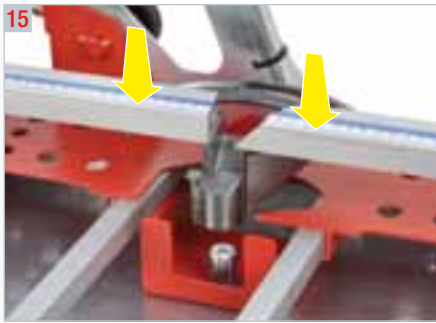

6 | ELECTRIC POWER SUPPLY



WARNING!

- Check the integrity of the cable and breakers.
- Respect the voltage (V) and frequency (Hz) indicated on the machine.
- Carry out the electrical connection with ground (yellow/green) to an IP67 outlet (2P+T) protected by an IΔN 0.01A differential breaker.
- Periodically check the operation of the differential breaker.
- For an extension, use only the IP67 (2P+T) socket and plug and a 3 x 2.5mm² cable of the H 07 RN-F type (max length 5 m).
- Check the placement of the power cable: it must not obstruct movement, and should not be subject to shock or damage.
- Remove the electrical connection during each routine or extraordinary maintenance operation, for the loading of coolant (water), or for the substitution of the diamond disk.
- Models equipped with a thermal protection switch and minimum voltage coil.
- Avoid forcing the motor during processing. The machine has a security system that protects it from engine overheating; consequently, if the motor is arrested without apparent reason, it is necessary to wait a few minutes so that the safety circuit is deactivated, as the machine has almost certainly been subjected to excessive force and the cutting advancement speed must therefore be moderated.
- IP55 single phase engine with electromagnetic emissions below the provided limits.
- In the case of malfunction regarding a breaker, cable, engine, or pump, consult an expert or our Technical Office.

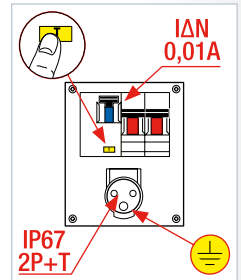

7 | CORRECT POSITIONING

- The operator must position himself in a safe and balanced way and must not be distracted during processing.
- The operator is always responsible for accidents that may occur to other people or their property.
- Do not allow other people to touch the machine or the cable. They must be kept away from the work space.
- It is advisable to wear rubber gloves and shoes with slip-resistant soles. If you have long hair, it must be gathered up or a protective cap used. Wear protective goggles.
- Use adequate hearing protection.
- Do not wear large clothing, objects or jewelry that can become stuck in moving parts.
- The work area must be flat, dry, free of obstacles, well ventilated and illuminated.
- Do not use the machine near flammable liquids or gas.
- Keep the cable away from high temperatures, oil, and sharp edges.
- Before starting any cutting operation, ensure that the column locking knobs are screwed to the bottom (fig. 1), that the legs are locked with the appropriate bolts (fig. 2-3), and check the cooling water level.

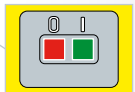
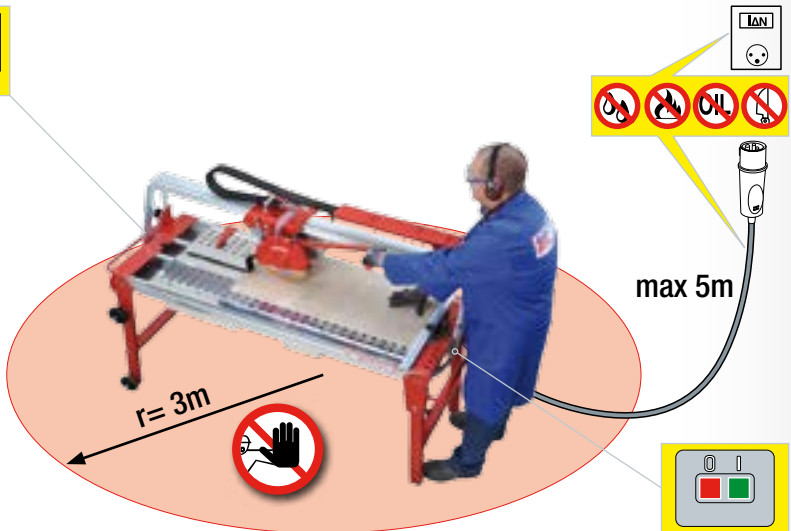
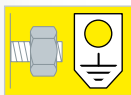

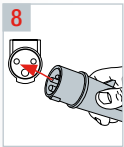
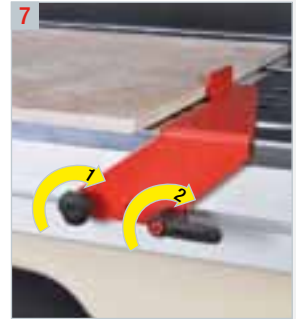
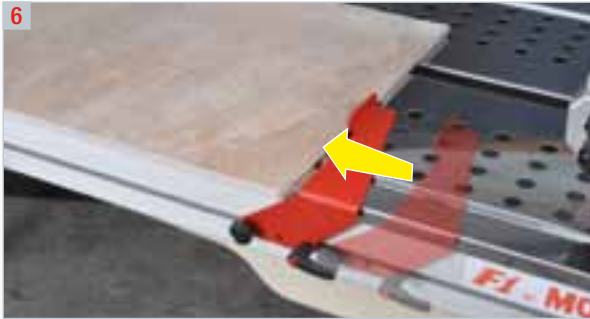
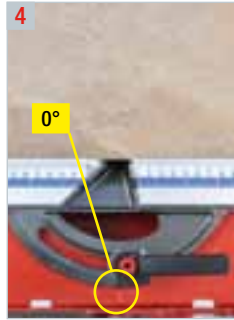
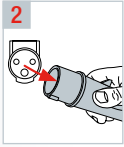
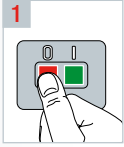

- Position the tile against the square. Lock the tile with Squeeze System (fig. 6/7).
- Press down to switch the driving handle and lock it.
- The correct position of the hands is shown in figure 10.
- Proceed to cutting by slowly positioning the diamond disk against the material to be cut, advancing with a speed proportional to the thickness and hardness of the material.
- Slow down the advancement speed near the end of cutting.
- After having completed the cut, turn the engine off through the switch. Bring the engine back to its original position.

8.1 CORRECT USE - SQUARE AND RECTANGULAR HOLES

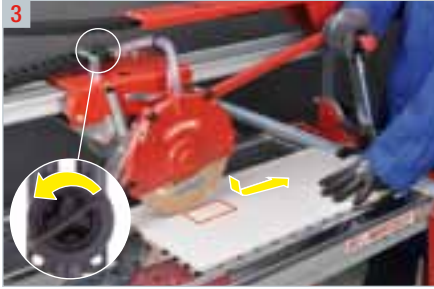
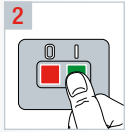
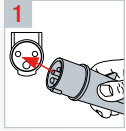

- Maximum material thickness 3.5 cm.
- Gradually press down on the driving handle so that the disk enters the plate and emerges from the opposite side.
- The correct position of the hands is shown in figure 3.

8.2 CORRECT USE - 45°

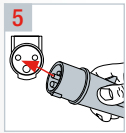
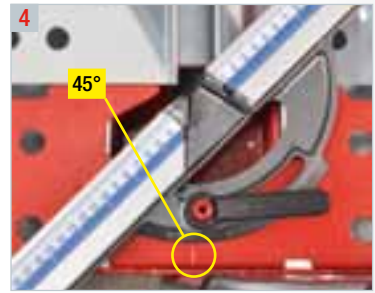
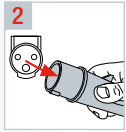
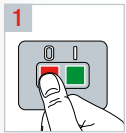

- Position the tile against the square.
- Press down to switch the driving handle and lock it.
- The correct position of the hands is shown in figure 7.
- Proceed to cutting by slowly positioning the diamond disk against the material to be cut, advancing with a speed proportional to the thickness and hardness of the material.
- Slow down the advancement speed near the end of cutting.
- After having completed the cut, turn off the engine through the switch. Bring the engine back to its original position.
- Whenever the end of the tile breaks (the last centimeter), sharpen the diamond disk. If the defect remains it can be remedied in the following way:
 - 1 - make a cut of about 2 cm from one side of the tile.
 - 2 - rotate it and follow the cut through until reunification with the 2 cm cut previously carried out.

8.3 CORRECT USE - JOLLY

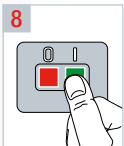
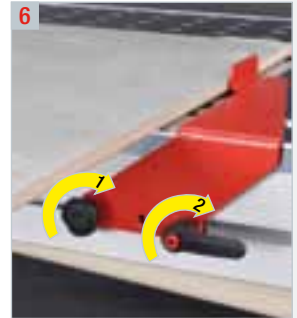
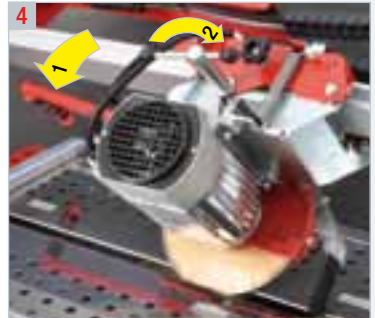
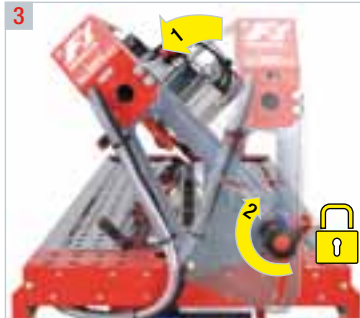
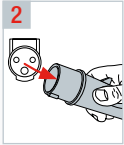
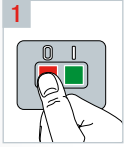

- Position the tile against the square. Lock the tile with Squeeze System (fig. 5/6).
- Press down to switch the driving handle and lock it.
- The correct position of the hands is shown in figure 9.
- Proceed to cutting by slowly positioning the diamond disk against the material to be cut, advancing with a speed proportional to the thickness and hardness of the material.
- Slow down the advancement speed near the end of cutting.
- After having completed the cut, turn off the engine through the switch. Bring the engine back to its original position.

9 INSTRUCTIONS FOR HANDLING AND TRANSPORT

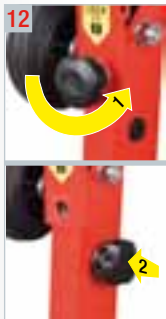
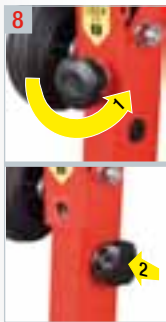
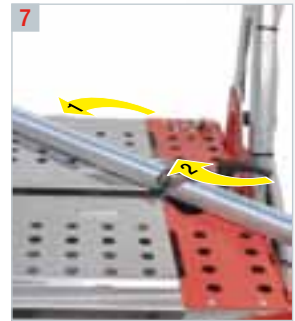
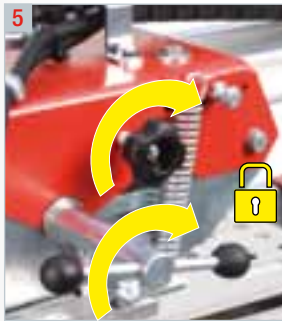
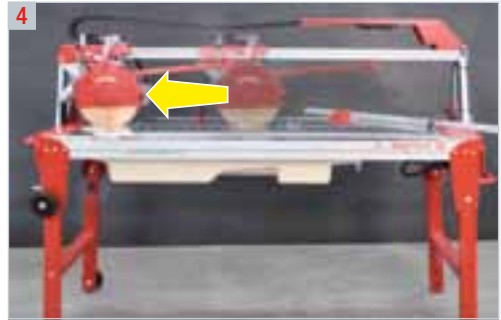
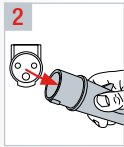
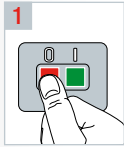

16



10) SUBSTITUTION OF THE DIAMOND DISK

- Use only diamond disks of the diameter and type set out by Brevetti MONTOLIT.
- For greater cut precision and economy, choose the MONTOLIT diamond disk specific to the use by consulting the MONTOLIT catalog.



IMPORTANT!

- The diamond tool and its mounting system must always be in perfect condition.
- The use of diamond tools with excessive wear, eccentricity and/or micro-scratches on the diamond crown is dangerous.
- In case the tool does not cut, it should be sharpened by using the appropriate MONTOLIT sharpening stick (art. 395B).

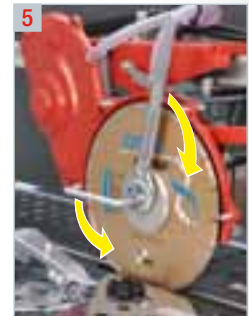
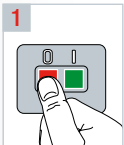

ATTENTION! Left thread: to unscrew, turn clockwise

11 PERIODIC CLEANING

- Prior to cleaning, maintenance or repair of equipment, as before transport, the machine must be turned off and unplugged.
- Machine cleaning:
 - do not use water jets but a wet sponge,
 - keep the scroll bar clean (not oily).
- The use of tools that may affect the paint is not recommended.
- Tank cleaning:
 - extract the grill and remove the cap, letting the water flow from the tank and proceeding to cleaning,
 - remove the tank and clean it of cutting debris and residue.

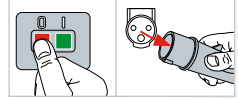

12 ROUTINE MAINTENANCE

- Periodically examine the machine cables, and in the case that they are damaged, have them repaired by the authorized technical service.
- Keep the handles dry, clean and without oil or grease.



ATTENTION!

Guards or other damaged parts should be properly repaired or replaced by the authorized technical service, unless otherwise indicated in this operation manual.

13 PUTTING OUT OF SERVICE

- Carry out regular cleaning and routine maintenance.
- Store everything in a dry, safe place, away from children.

14 DISMANTLING OF THE MACHINE

- Follow the local provisions for the disposal of electrical products.
- Valuable materials can be recovered by recycling.
- The electrical components used for construction are in accordance with the regulation RoHS 2002/95/EC.
- Contact our Technical Office for further information.



15 ACCESSORIES

- The machine comes with a simple forked wrench and a hexagonal wrench to use for disk mounting/dismantling, of an already mounted disk series in this use and maintenance manual.

16 LOCATION TROUBLESHOOTING

| PROBLEM | CAUSE | REMEDY |
|---|---|--|
| The machine is not working. | <ul style="list-style-type: none"> • The plug is badly inserted in the power socket. • The power cable is interrupted. • There is no voltage at the outlet. • The switch is damaged. • The engine is not connected. | <ul style="list-style-type: none"> • Push the plug into the outlet all the way. • Consult the authorized service center or dealer. |
| The engine starts with difficulty. | <ul style="list-style-type: none"> • The condenser is broken. • The voltage indicated on the technical data tag does not reach the motor. | <ul style="list-style-type: none"> • Consult the authorized service center or dealer. |
| The machine turns off during working. | <ul style="list-style-type: none"> • Excessive engine temperature. | <ul style="list-style-type: none"> • Wait for the engine to cool. |
| Water does not get to the diamond disk. | <ul style="list-style-type: none"> • The pump is not working. • The water level in the tank is too low. • The tap is blocked. • The water recirculation tube is bent or blocked. • Clogged holes in the filter or in the pump rotor cover. | <ul style="list-style-type: none"> • Make sure that the pump is free of cutting debris. If the pump needs to be substituted, contact the authorized service center or dealer. • Add water to the tank. • Clean or replace the tap. • Remove the water delivery tube from the pump and blow into it. Clean or substitute it according to its state of wear. • Unblock all of the holes present in the filter and pump rotor cover. |
| The slider has excessive play. | <ul style="list-style-type: none"> • Excessive wear. | <ul style="list-style-type: none"> • Consult the authorized service center or dealer. |

17 GUARANTEE

Valid for 2 (two) years from the date of sale (invoice or delivery note or sales tax receipt).
Breakdowns resulting from non-conforming use or normal wear are excluded from this guarantee.

Brevetti MONTOLIT has always employed and provided first choice materials. This is a commitment to seriousness and commercial morality that elevates our company to the highest standard. The product's safety and warranty are a source of pride for us. This operational reality is not just words, but a real and written guarantee. In fact, we ensure all of our products against involuntary damage caused by accidents occurring as a result of a construction or manufacturing defect, even after delivery and commercialization.



The descriptions and diagrams are intended to provide a simple means of illustration. The Company reserves the right, without prejudice to the essential characteristics of the models described and illustrated here, to make any modifications it deems necessary for improvement or for any constructive or commercial need at any time and without notice.

All total or partial reproductions of this document in any format or by any means or procedure, photographic or electronic, without prior authorization of Brevetti MONTOLIT S.p.A. is prohibited. Each of these activities could lead to subsequent criminal proceedings.



Art. 1305F1 *(standard x mod. 181cm)*

- KIT AVANZAMENTO CON VOLANTINO
- *KIT CUTTING PROGRESS SYSTEM WITH HAND WHEEL*



Art. 58E

- TAPPETINO IN GOMMA PER MOSAICI, PIASTRELLE IN VETRO, DELICATE E SOTTILI (3MM).
- *RUBBER PAD FOR MOSAIC TILES, PLUS DELICATE AND VERY THIN 3MM GLASS TILES.*



Art. 1051

Art. 1049 - Art. 1051

- TAVOLINO DI SUPPORTO LATERALE
- *LATERAL SUPPORT TABLE*



Art. 1049

| Nr. | Art. | Descrizione | Description |
|-----|----------|--|--|
| 1 | 1080MB | Motore 230V~/50Hz | 230V~/50Hz - Motor |
| 1 | 1081MB | Motore 115V~/60Hz | 115V~/60Hz - Motor |
| 2 | 1208F1 | Carter copridisco completo | Complete blade guard |
| 3 | 1088 | Paraspruzzi | Water - splash guard |
| 4 | 1103MB | Flangia disco completa | Complete blade flange |
| 5 | 1195 | Cuscinetto | Wheel - bearing |
| 6 | 1132 | Rubinetto dell'acqua | Water tap |
| 7 | 1126F1 | Pomolo bloccaggio piantone | Screw for upright |
| 8 | 1095F1SX | Supporto SX | Upright SX |
| 9 | 1161F1 | Bloccaggio piastrella "Squeeze System" | Clamp for tile "Squeeze System" |
| 10 | 1300F1 | Binario x mod. 101cm | Sliding bar x mod. 101cm |
| 10 | 1301F1 | Binario x mod. 131cm | Sliding bar x mod. 131cm |
| 10 | 1302F1 | Binario x mod. 151cm | Sliding bar x mod. 151cm |
| 10 | 1303F1 | Binario x mod. 181cm | Sliding bar x mod. 181cm |
| 11 | 1305F1 | Kit avanzamento con volantino | Kit cutting progress system with hand wheel |
| 12 | 1201 | Nasello | Measurement guide |
| 13 | 450P | Manettino bloccaggio squadra | Screw measurement guide |
| 14 | 1073EV | Righette adesive millimetriche | Measurement guide stickers |
| 15 | 1089EV | Squadra goniometrica x mod. 101-131cm | Goniometrical square x mod. 101-131cm |
| 15 | 1198EV | Squadra goniometrica x mod. 151-181cm | Goniometrical square x mod. 151-181cm |
| 16 | 1307F1 | Lamiera inox "corta" con apertura x mod. 131cm | Stainless steel support "short" with opening x mod. 131cm |
| 16 | 1308F1 | Lamiera inox "lunga" con apertura x mod. 101-151-181cm | Stainless steel support "long" with opening x mod. 101-151-181cm |
| 17 | 1309F1 | Lamiera inox "corta" x mod. 131-151cm | Stainless steel support "short" x mod. 131-151cm |
| 17 | 1310F1 | Lamiera inox "lunga" x mod. 101-151-181cm | Stainless steel support "long" x mod. 101-151-181cm |
| 18 | 1095F1DX | Supporto DX | Upright DX |
| 19 | 1312F1 | Pomolo bloccaggio gamba | Screw for locking leg |
| 20 | 1191 | Interruttore 230V~ | 230V~ - Switch |
| 20 | 1155 | Interruttore 115V~ | 115V~ - Switch |
| 21 | 1082 | Pompa elettrica ad immersione - 230V~ x mod. 101-131cm | 230V~ - Electric immersion pump x mod. 101-131cm |
| 21 | 1082F1 | Pompa elettrica ad immersione - 230V~ x mod. 151-181cm | 230V~ - Electric immersion pump x mod. 151-181cm |
| 21 | 1083 | Pompa elettrica ad immersione - 115V~ x mod. 101-131cm | 115V~ - Electric immersion pump x mod. 101-131cm |
| 21 | 1083F1 | Pompa elettrica ad immersione - 115V~ x mod. 151-181cm | 115V~ - Electric immersion pump x mod. 151-181cm |
| 22 | 1206F1 | Vasca dell'acqua con tappo di scarico | Water tank with drain plug |
| 23 | 302F1 | Ruota | Wheel |

F1

BROOKLYN

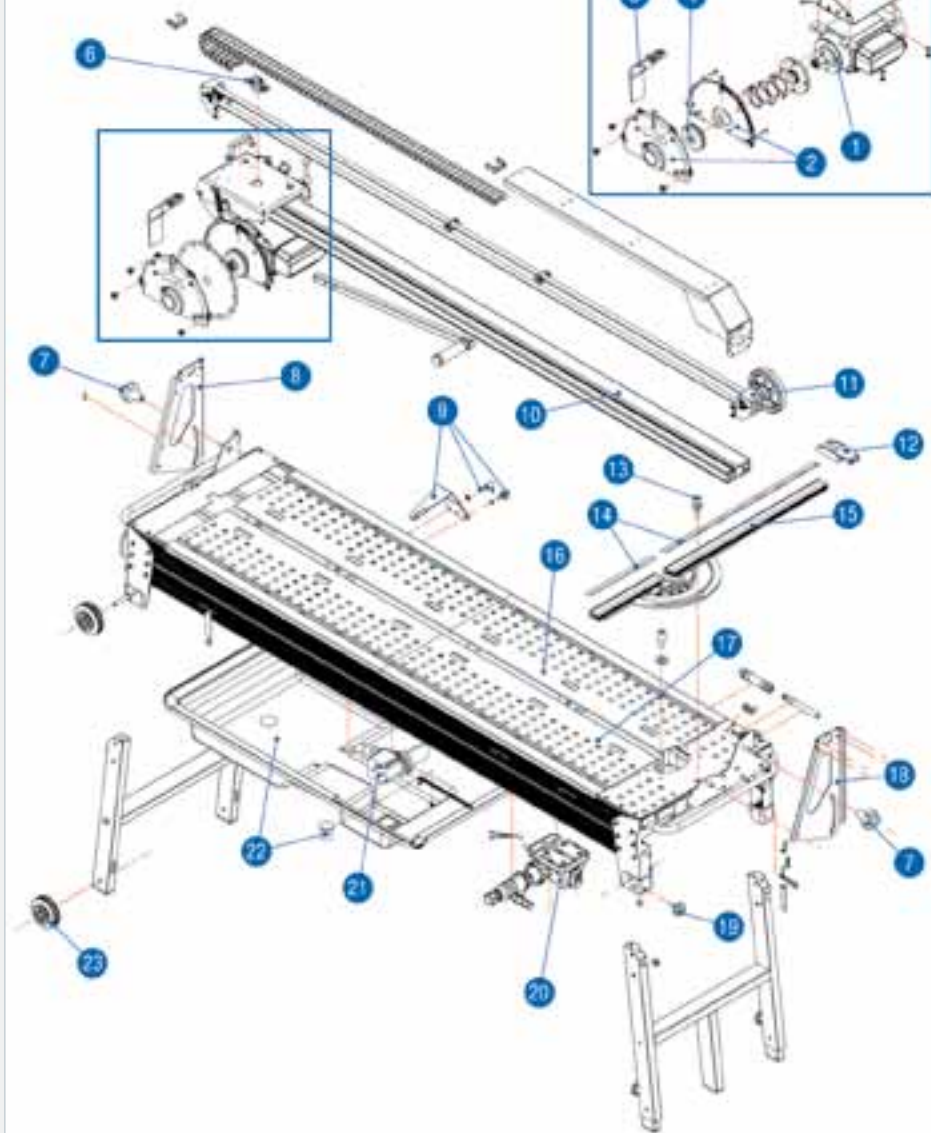



SINCE 1946

Brevetti Montolit S.p.A.

Sedi operative/ Company headquarters:

Largo Cav. Montoli - 21050 Cantello (VA) Italy

Via Varese 4/A - 21050 Cantello (VA) Italy

Sede legale/Legal head office:

Via Turconi, 25 - 21050 Cantello (VA) Italy

Tel. ++39 0332 419 211

Fax ++39 0332 418 444

www.montolit.com - info@montolit.com